

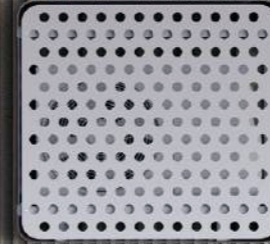

# AirShield



Secure your Cooling

[AIR-SHIELD.CO](https://air-shield.co)



# Contents

## Company

---

Company Principles	2
Products Overview	3
Innovation is in our DNA	4
Strong Foundation	5

## Our Products

---

Blade	8
Curve	9
Bird	10
Provence	11
HiFi	12

## The Details

---

Easy Mounting	15
Technical Specs	16

# Designed in Italy. Made in Slovenia.

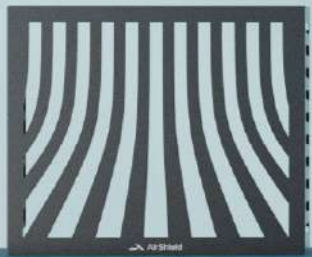

## COMPANY PRINCIPLES

# We specialise in delivering innovative & stylish solutions.

We are dedicated to the manufacture of superior quality products. Our commitment lies in merging elegant design with superior craftsmanship, delivering only premium AC covers to our clients. Striving for excellence is our standard.



**Andrej Volpi**  
CEO

Seasoned entrepreneur with numerous successful businesses under his belt, armed with 25+ years of experience in managing and growing businesses on a global scale. Present endeavors include pinpointing market needs and developing fresh global enterprises.

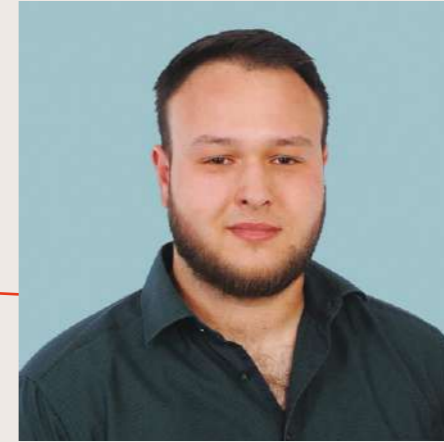

**Jan Volpi**  
Sales Manager

A proficient Science Engineer, with experience contributing to several significant incubators and a proud alumnus of ITM Management School. Specialises in catalysing business development and driving sales through strategic partnerships.



**Nik Volpi**  
CTO

Mechanical engineer, leading the Production and Development team, with a strong understanding of technical modelling and industrial design. Specialises in designing AC covers that perfectly balance durability with aesthetics.

## PRODUCTS OVERVIEW

# Designed to last & beautify your real estate.

AirShield AC covers are not just functional shields for your outdoor AC units, but also stylish enhancements. Expertly designed to withstand severe weather and prolong your unit's lifespan, they are there to add a touch of elegance to your outdoor space.

## PRODUCT SHOWCASE



# Experience the Difference

INNOVATION IS IN OUR DNA

# Innovation meets **Aesthetics.** Function meets **Durability.**

We are dedicated to setting new standards in outdoor aesthetics, transforming utility into art. Elevate your home with AirShield AC covers – where sophistication meets sustainability.

PRODUCT SHOWCASE



STRONG FOUNDATION

# Premium-grade materials, stacked in **perfect** layers.

Designed for ensuring an optimal balance of rigidity and flexibility for superior protection and fit of your outdoor AC units.

- 1 Protective Film
- 2 Paint Finish
- 3 Aluminium Skin
- 4 Adhesive Layer
- 5 Polymer Core

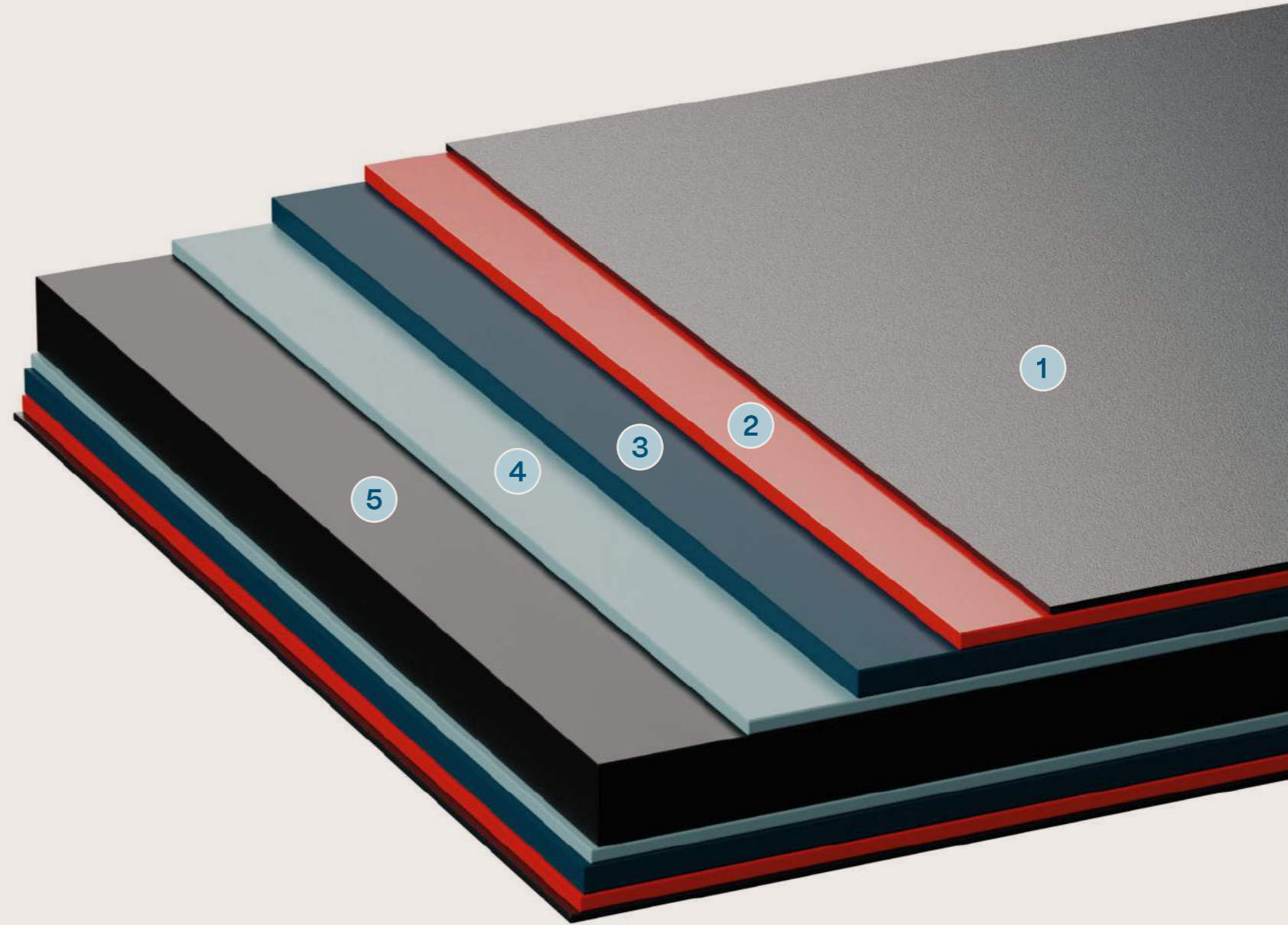



# Stylish & Innovative

We believe in creating an environment that you love & understand the significance of personal pride in the design of your home. Let's build that sentiment together.



-  Unmatchable build quality
-  Enhances building's aesthetics
-  Ultimate all-weather protection
-  Improved noise reduction
-  Durable & quality materials
-  Versatile compatibility options

CLASSIC SERIES

# Blade

A rigorous and elegant architectural shape, suitable for any installation.

SIZES

S

M

L

XL

COLORS

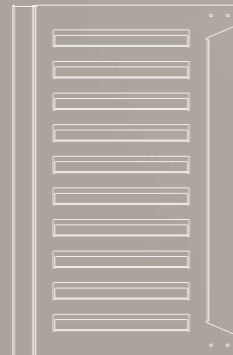

CLASSIC SERIES

# Curve

A smooth and enveloping style,  
classic and innovative at the same time.

SIZES

S

M

L

XL

COLORS

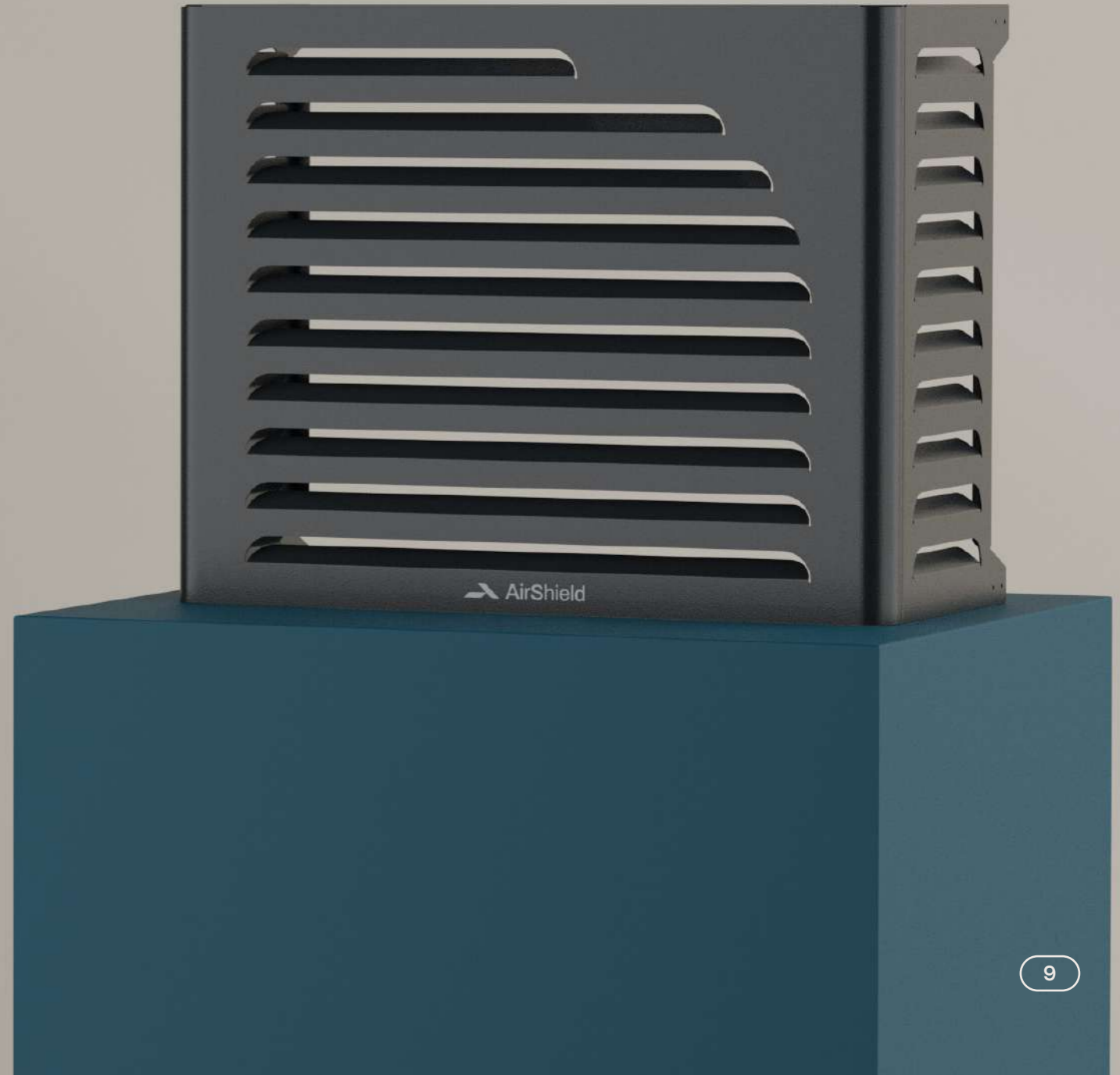
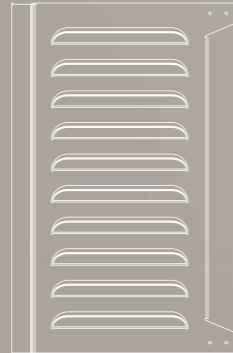

CLASSIC SERIES

# Bird

Design inspired by the ancient oriental art of origami, original and ageless.

SIZES

S

M

L

XL

COLORS

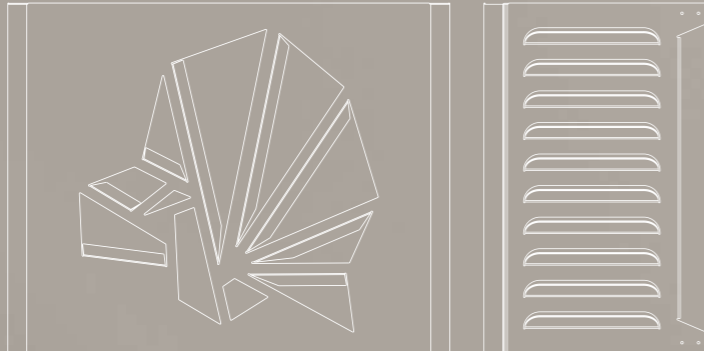

CLASSIC SERIES

# Provence

A line inspired by the endless lavender fields of southern France.

SIZES

S

M

L

XL

COLORS

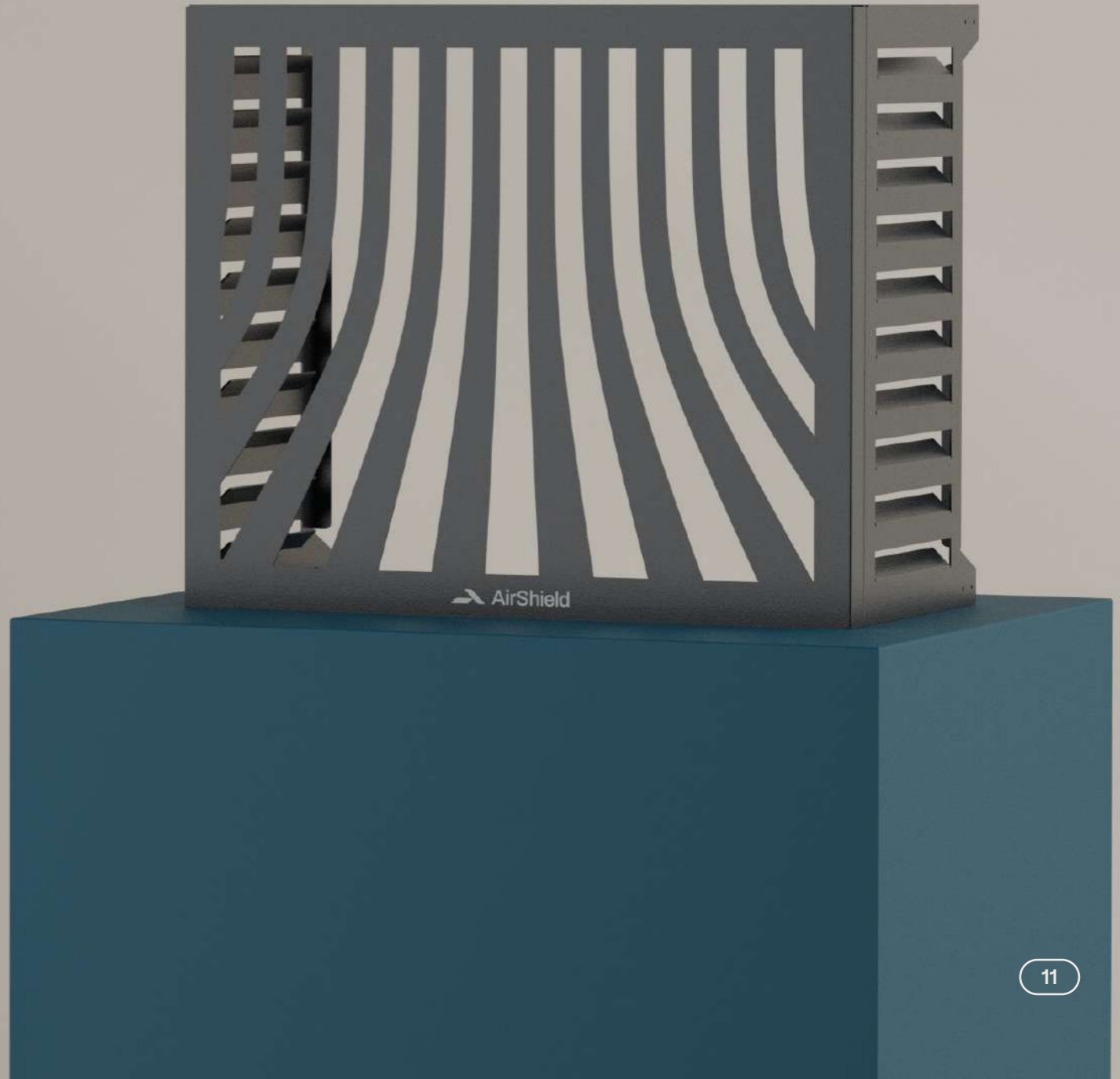
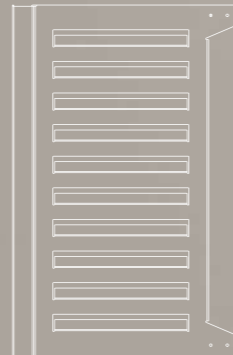
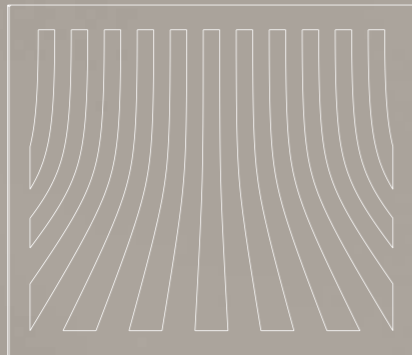

SPECIAL SERIES

# HiFi

A unique and timeless design for those who dislike the usual rectangular boxes.

SIZES

S

M

L

XL

COLORS

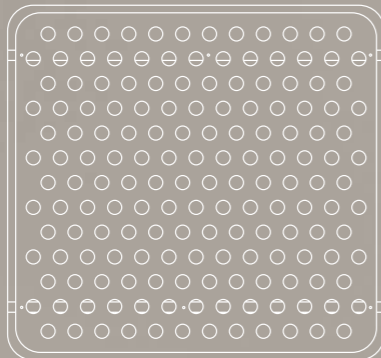

ELEVATED MINIMALISM

# Attention to **details** is ingrained in company **culture.**

AirShield covers strike the right balance between detail and minimalism. They blend into your exterior decor, adding value to your property and safeguarding your AC units without demanding undue attention.

PRODUCT SHOWCASE



# Respect the Details

PRODUCT SHOWCASE

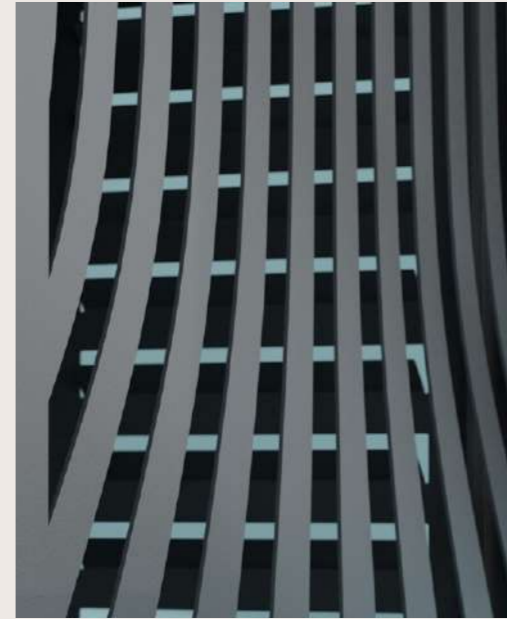

Embodying art in utility, every cover is an artistic expression in its own right. Balancing minimalist design with intricate detailing, these covers add just the right amount of subtle sophistication to your property while ensuring optimal AC unit protection.

STACK IT AS YOU WANT

# Effortless mounting made accessible for **every** situation.

Offering six adaptable mounting options and diverse add-ons, we aim to simplify the installation process, catering to any situation.



**Adjustable feet**



**Back panel**



• **Wall-Mounted**



• **Wall-Mounted (floor level)**



• **Floor-Standing**



• **Stacked Wall-Mounted**



• **Stacked (floor level)**



• **Independent**

# Technical Specs

## SPECIAL SERIES

### HiFi

Size	External dimensions	Available inner space	Bottom side opening
<b>S</b>	(W) <b>92cm</b> x (H) <b>76cm</b> x (D) <b>52cm</b>	(W) <b>82cm</b> , (H) <b>67cm</b> , (D) <b>45cm</b>	(W) <b>60cm</b> , (H) <b>36cm</b>
<b>M</b>	(W) <b>102cm</b> x (H) <b>91cm</b> x (D) <b>57cm</b>	(W) <b>92cm</b> , (H) <b>82cm</b> , (D) <b>50cm</b>	(W) <b>70cm</b> , (H) <b>39cm</b>
<b>L</b>	(W) <b>107cm</b> x (H) <b>101cm</b> x (D) <b>62cm</b>	(W) <b>97cm</b> , (H) <b>92cm</b> , (D) <b>55cm</b>	(W) <b>75cm</b> , (H) <b>42cm</b>

Hi-Fi is a distinctive and stylish AC cover, belonging to the Special Series and not compatible with Classic Series accessories. With its timeless design, it departs from conventional rectangular boxes, ensuring suitability for any installation.

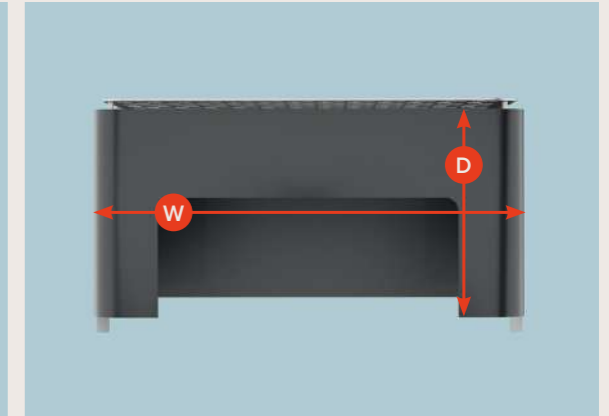
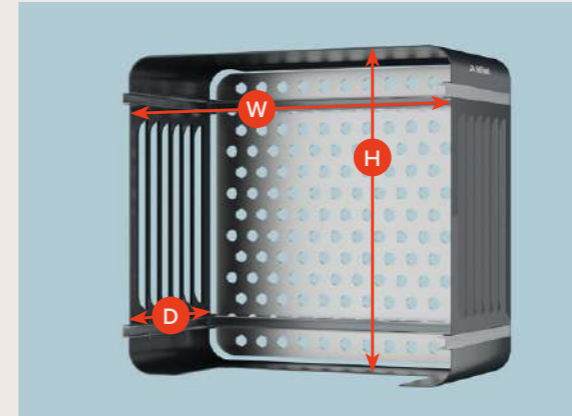

## CLASSIC SERIES

### Blade Curve Provence Bird

Size	External dimensions	Available inner space
<b>S</b>	(W) <b>90cm</b> x (H) <b>70cm</b> , (D) <b>from 46cm to 52cm</b>	(W) <b>82cm</b> , (H) <b>66cm</b> , (D) <b>from 42cm to 48cm</b>
<b>M</b>	(W) <b>100cm</b> x (H) <b>85cm</b> , (D) <b>from 54cm to 60cm</b>	(W) <b>92cm</b> , (H) <b>81cm</b> , (D) <b>from 50cm to 56cm</b>
<b>L</b>	(W) <b>105cm</b> x (H) <b>95cm</b> , (D) <b>from 59cm to 65cm</b>	(W) <b>97cm</b> , (H) <b>91cm</b> , (D) <b>from 55 to 61cm</b>

The Classic Series covers form a unified system with different shapes but identical dimensions. They are compatible with the same accessories and have an adjustable bracket for wall distance (0-60 mm).

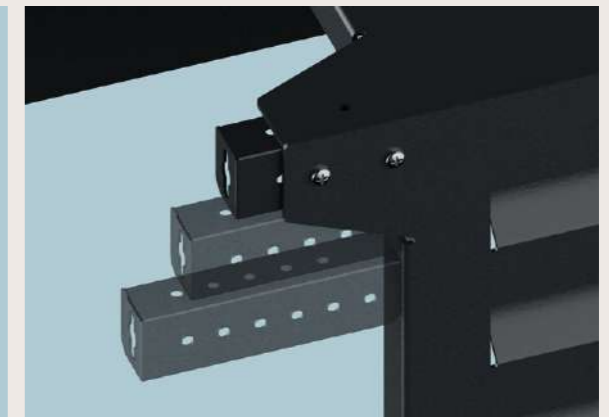
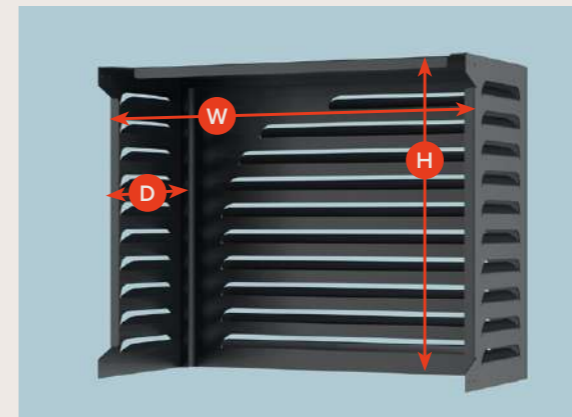



# Innovate & Protect

Cover up in Style

**AirShield**

Kraška ulica 4  
6210 Sežana (SLO)

+386 41 428 311  
info@air-shield.co



[AIR-SHIELD.CO](https://www.air-shield.co)